

PALCO 4X6

- ALTEZZA PALCO DA 78 A 122 cm
- PESO TOTALE 568 Kg

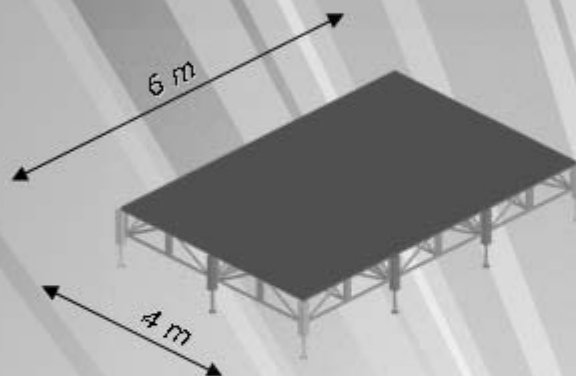

SCHEMA STRUTTURA PORTANTE

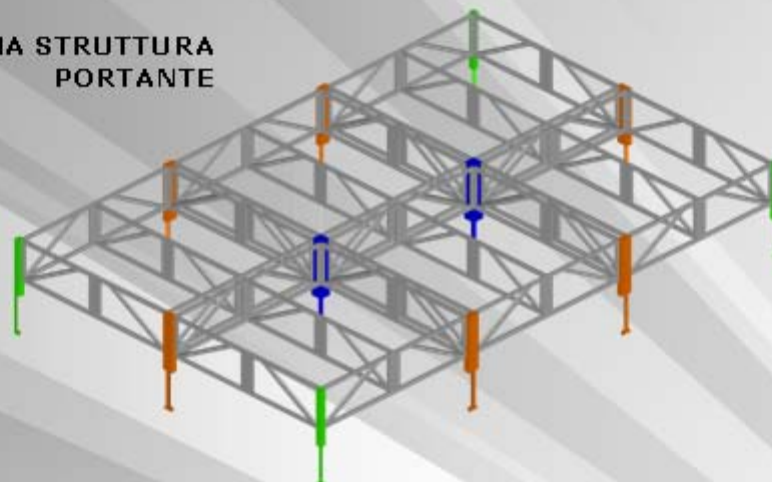

- KP 66 S 
- KP 61 S 
- KP 11 S 
- T 200 
- RE 200 

DISTINTA PARTICOLARI PER IL PALCO COMPLETO

- PARTICOLARI PRINCIPALI
 - N° 4 KP 66 S
 - N° 6 KP 61 S
 - N° 2 KP 11 S
 - N° 30 T 200
 - N° 12 pianali SD1020
- PARTICOLARI PER IL COLLEGAMENTO
 - N° 24KDC